

Origami

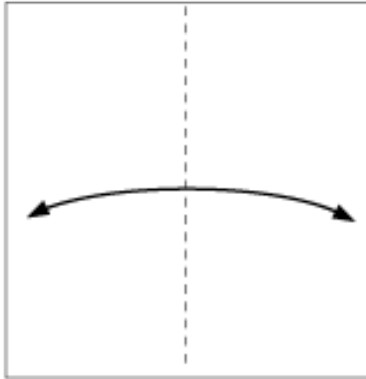

1 Pliez-en deux pour marquer le pli

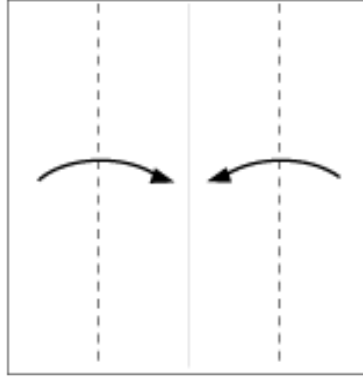

2 Pliez vers le centre de la feuille

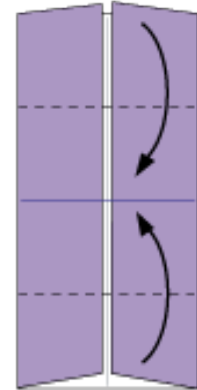

3 Pliez vers le centre de la feuille

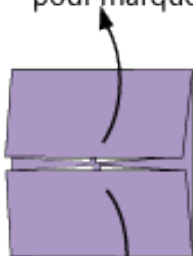

4 Marquez le pli

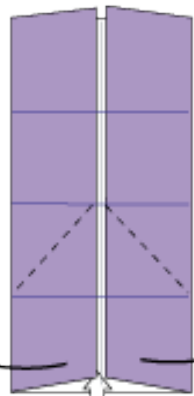

5 Abra sobre y recúbralo

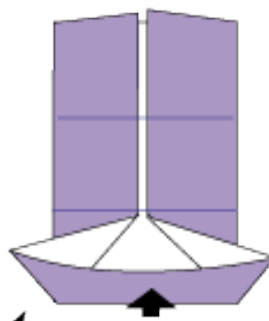

6 J'ai écrasé

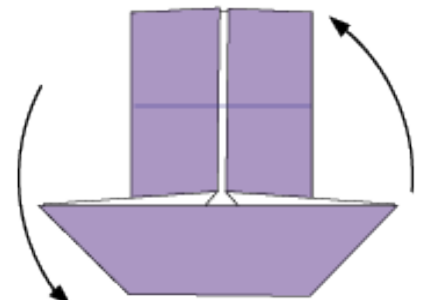

7 Cambie de lado

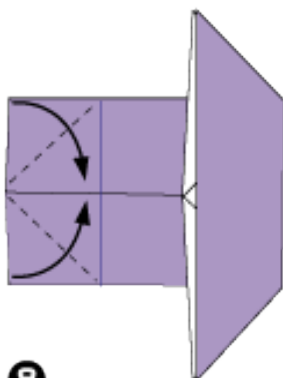

8 Pliez vers le centre de la feuille

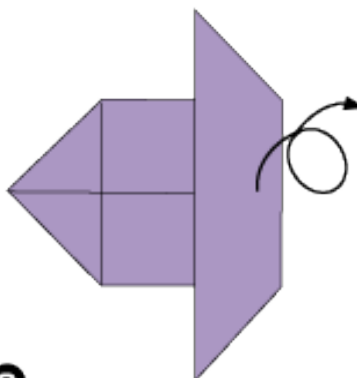

9 Changez de côté

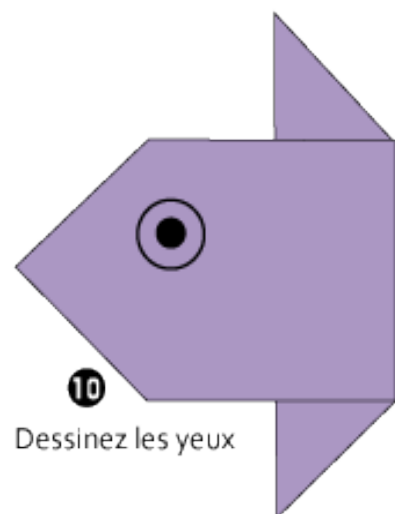

10 Dessinez les yeux

Origami

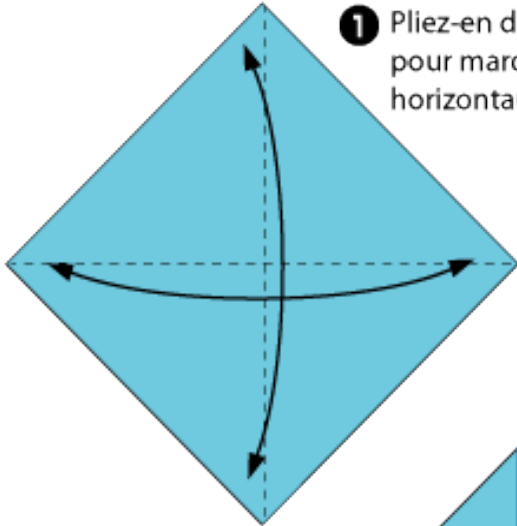

1 Pliez-en deux dans les deux sens pour marquer les plis verticaux et horizontaux du centre

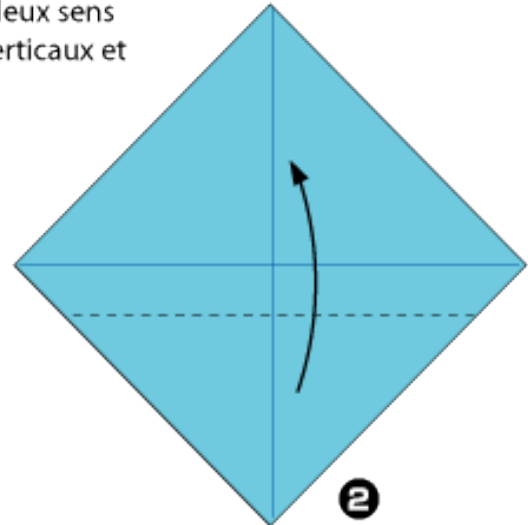

2 Pliez sur les pointillés

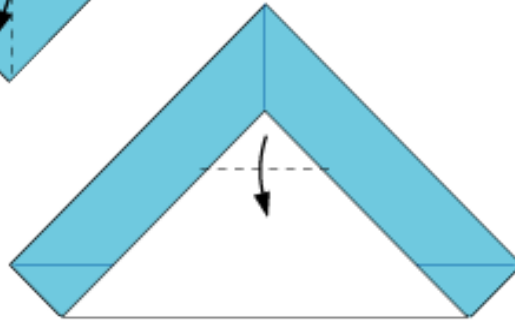

3 Pliez sur les pointillés

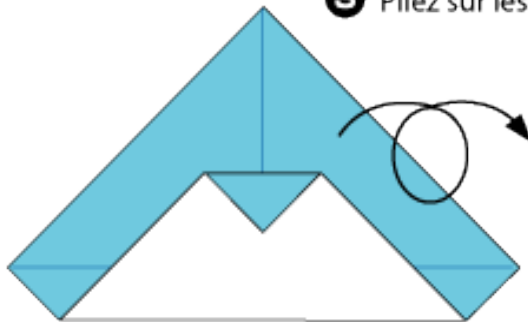

4 Changez de côté

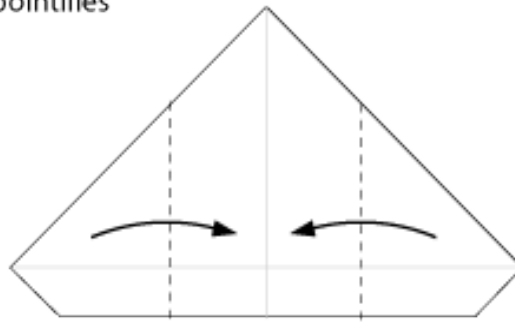

5 Pliez sur les pointillés

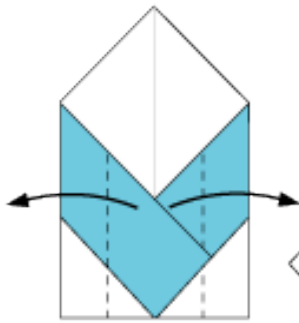

6

Pliez sur les pointillés

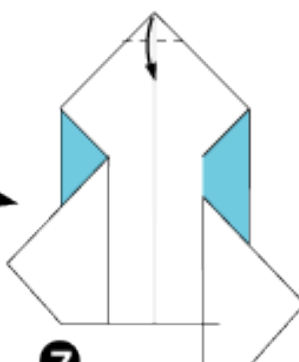

7

Pliez sur les pointillés

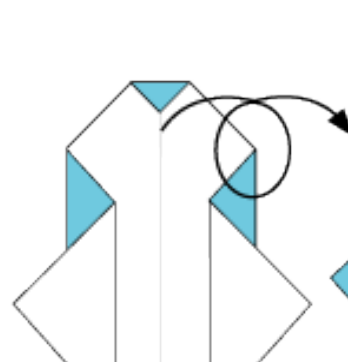

8 Changez de côté

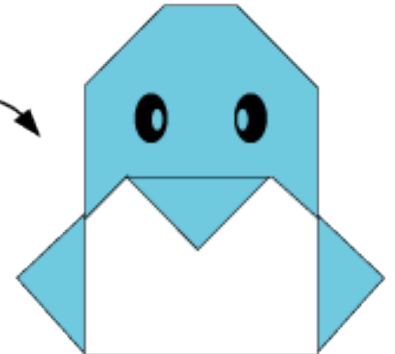

Pingouin

*Copyright:Fumiaki Shingu

Origami

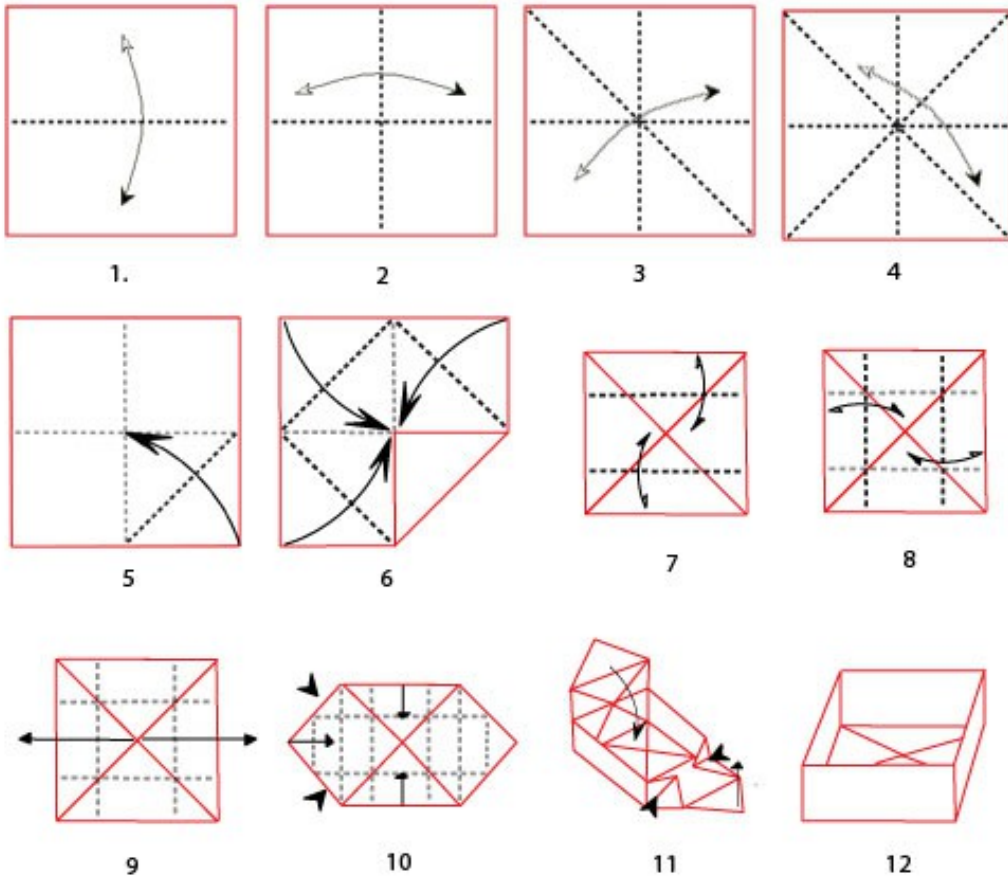

Plier et déplier pour marquer



Retourner le travail



Tirer



Plier vers l'avant



Plier vers l'arrière



Ouvrir



Pousser



Faire pivoter le travail

Origami



1.

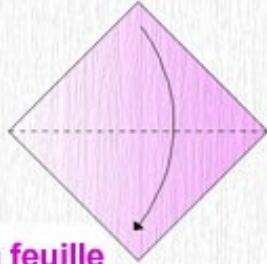

Plier la feuille en deux

2.



Plier en deux en suivant les pointillés

3.

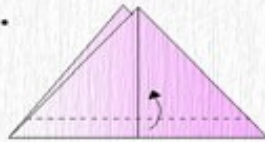

Plier en suivant les pointillés

4.

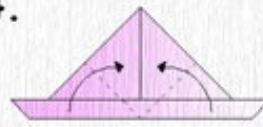

Plier en suivant la ligne médiane (pointillés)

5.

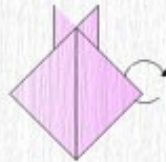

Retournez l'origami

6.

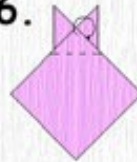

Plier en suivant les pointillés

7.



Plier en bas suivant les pointillés

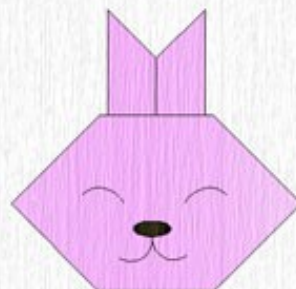

LAPIN

Origami

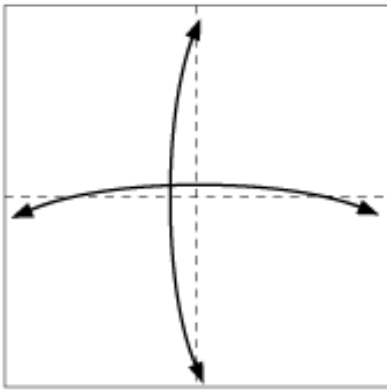
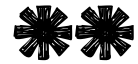

1 Fold in half to make creases and fold back

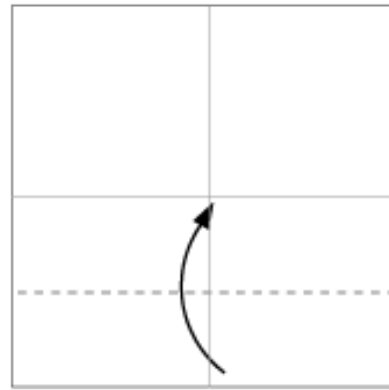

2 Fold to meet the center line

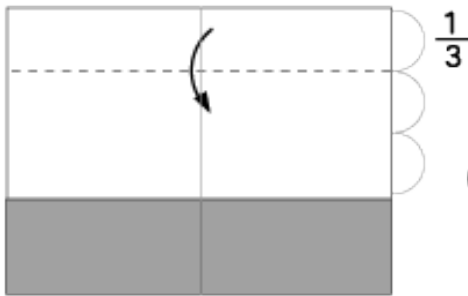

3 Fold in the dotted line

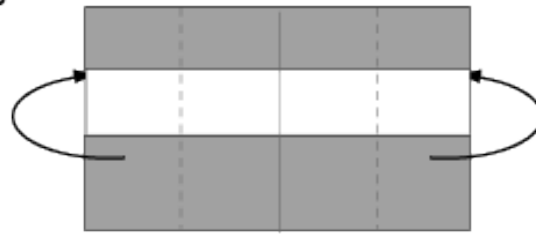

4 Fold backward in the dotted line

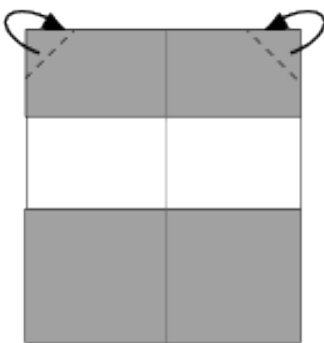

5 Fold backward in the dotted line

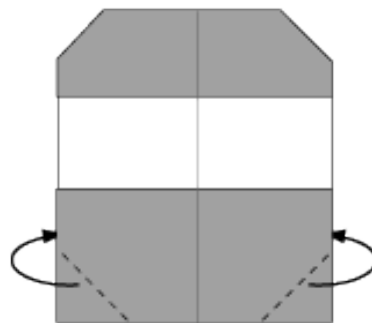

6 Fold backward in the dotted line

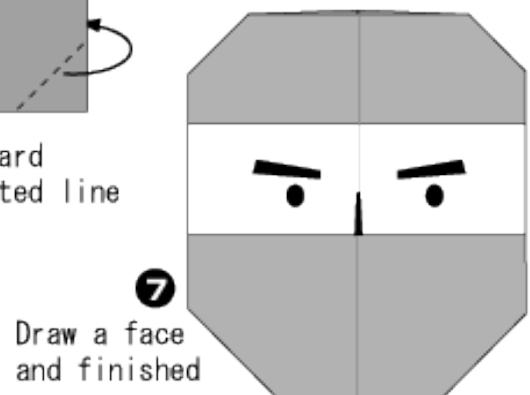

7 Draw a face and finished

A Ninja

Origami

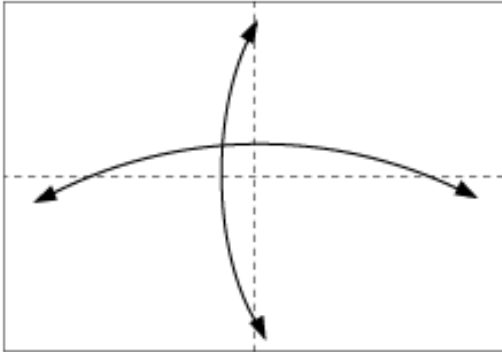
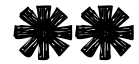

1 Pliez-en deux dans les deux sens pour marquer les plis verticaux et horizontaux du centre

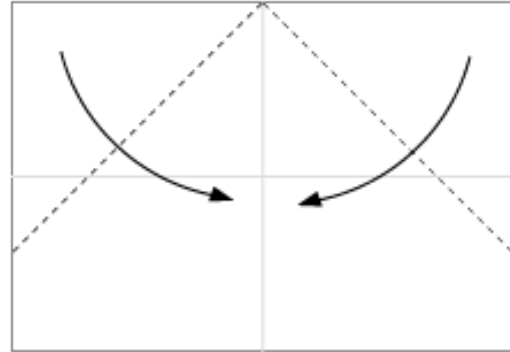

2 Pliez vers le centre de la feuille

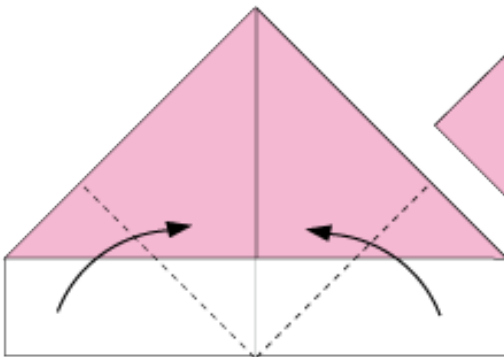

3 Pliez vers le centre de la feuille

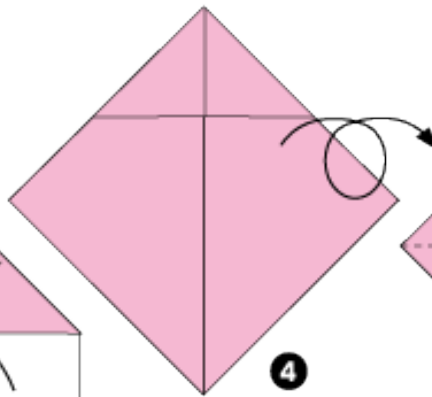

Changez de côté

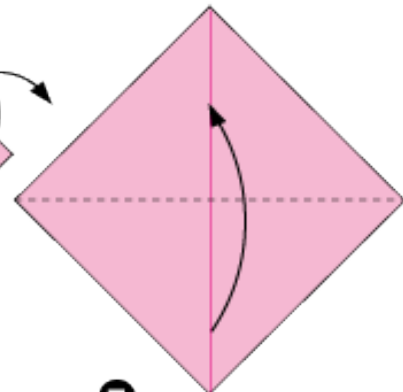

5

Pliez vers le centre de la feuille

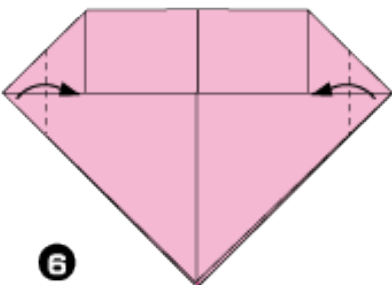

6

Pliez vers le centre de la feuille

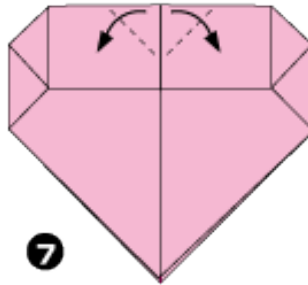

7

Pliez vers le centre de la feuille

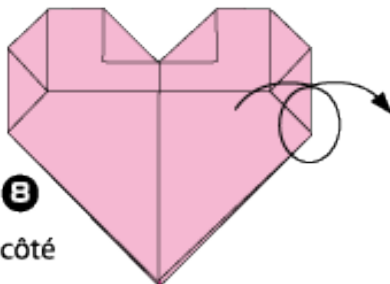

8

Changez de côté

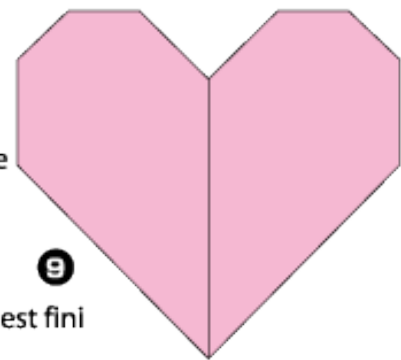

9

C'est fini

Origami

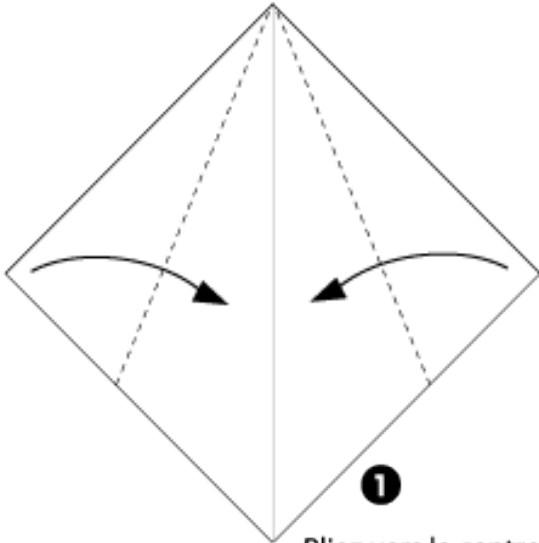
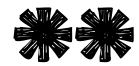

1
Pliez vers le centre
de la feuille

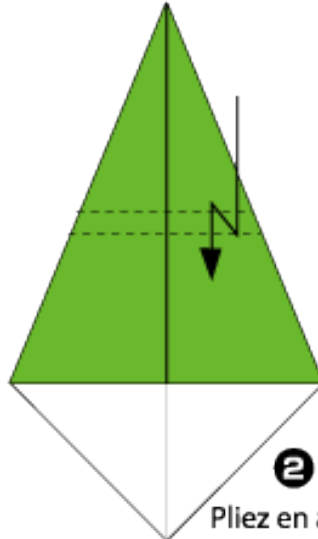

2
Pliez en accordéon
sur les pointillés

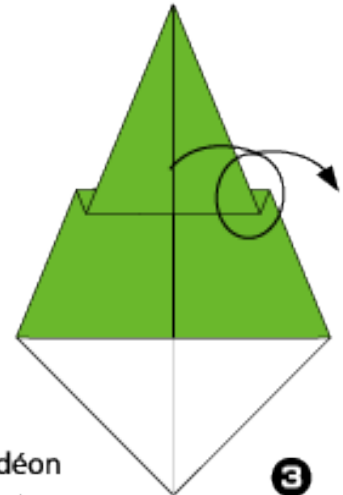

3
Changez de côté

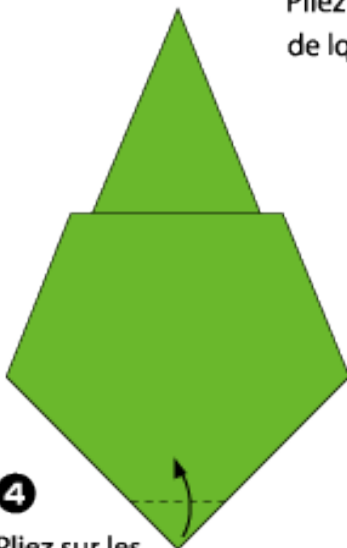

4
Pliez sur les
pointillés

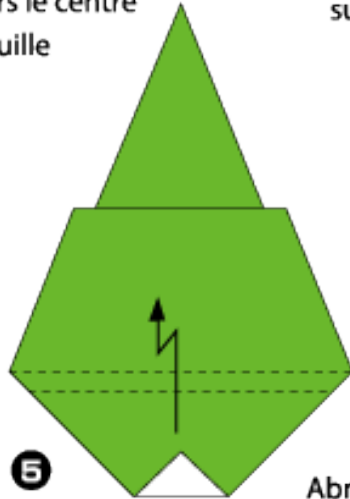

5
Pliez en accordéon
sur les pointillés

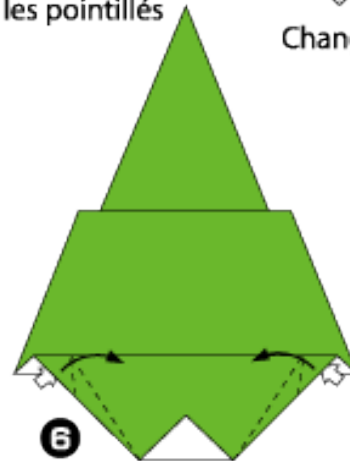

6
Abra sobre y recúbralo

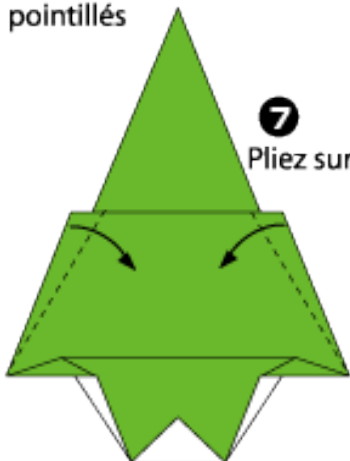

7
Pliez sur les pointillés

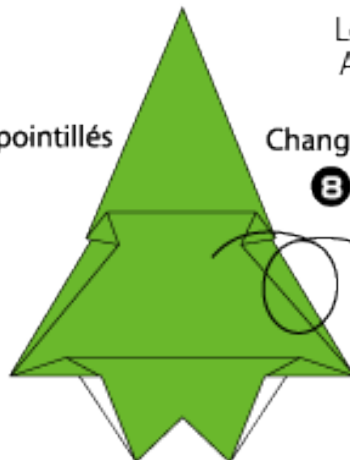

8
Changez de côté



9
Lequel était en
Avec affichage

Lequel était en

Origami

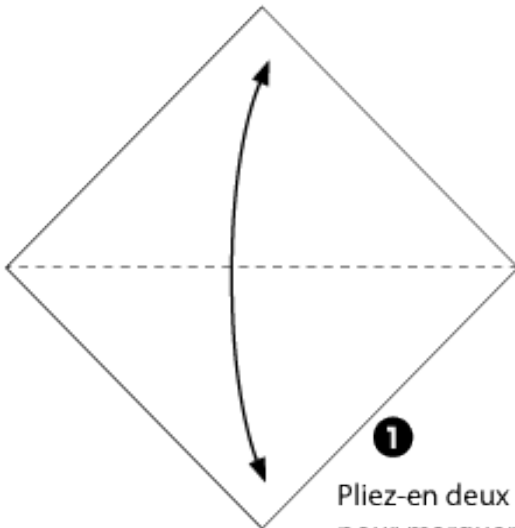
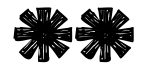

1
Pliez-en deux
pour marquer le pli

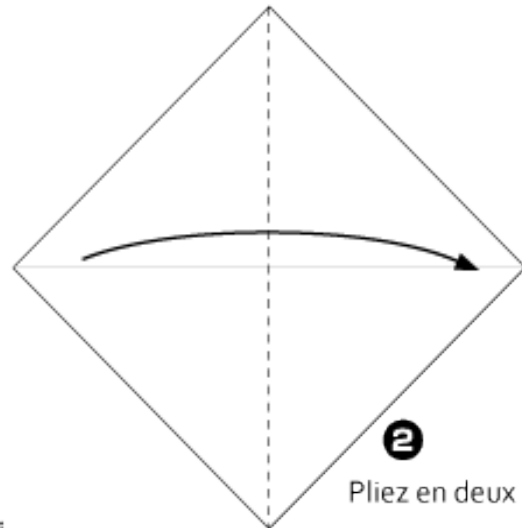

2
Pliez en deux

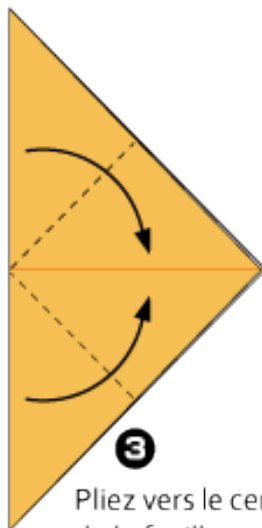

3
Pliez vers le centre
de la feuille

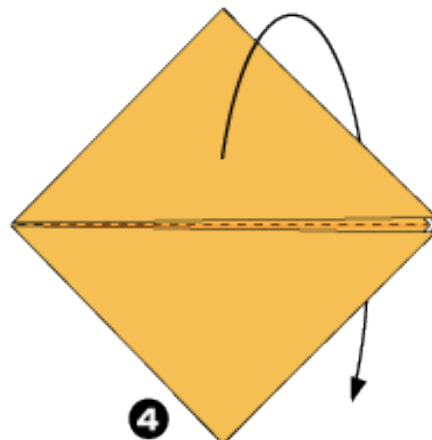

4
Pliez en deux

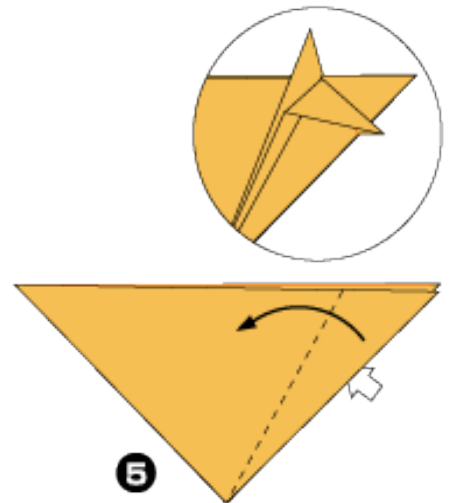

5
Abra sobre  y recúbralo

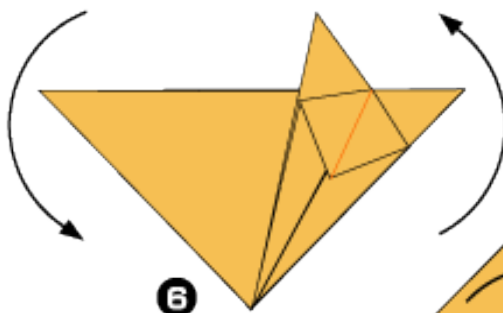

6
Cambie de lado

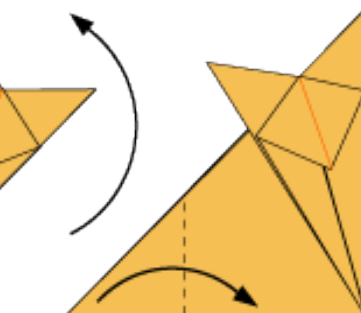

7 Pliez sur les pointillés

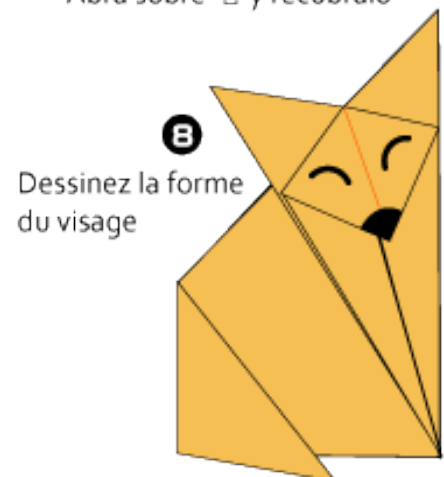

8
Dessinez la forme
du visage

*Copyright:Fumiaki Shingu

Un renard

Origami

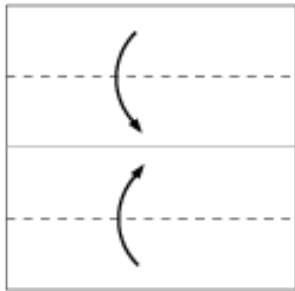
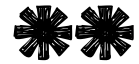

1 Pliez vers le centre de la feuille

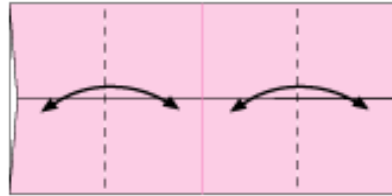

2 Marquez le pli

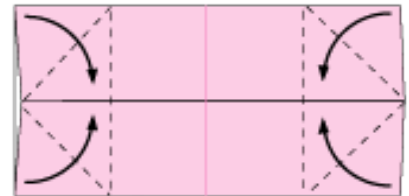

3 Pliez sur les pointillés

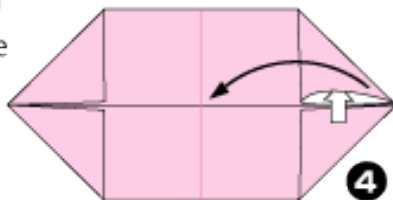

Abra sobre ↑ y recúbralo

4

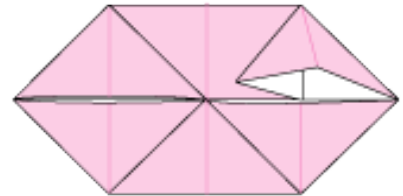

5 Répétez les autres côtés

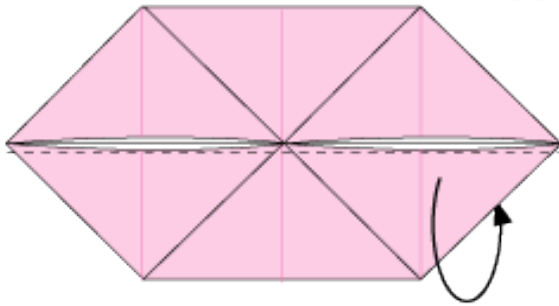

6 Pliez la feuille en arrière sur les pointillés

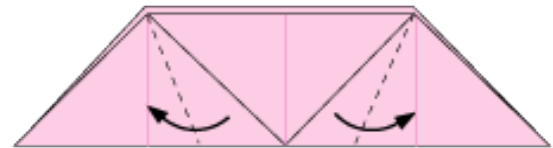

7 Pliez sur les pointillés

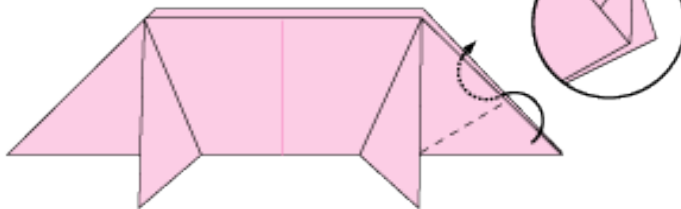

8 Contre pliage vers l'intérieur sur les pointillés

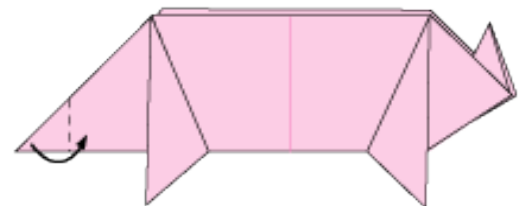

9 Pliez sur les pointillés

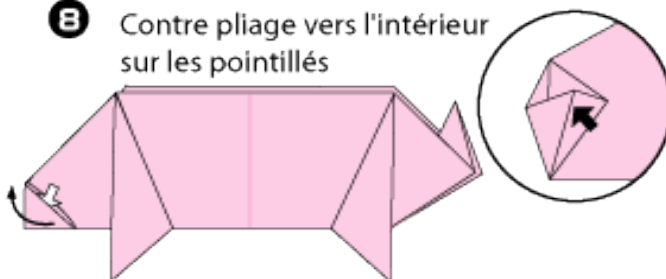

10 Abra sobre ↑ y recúbralo

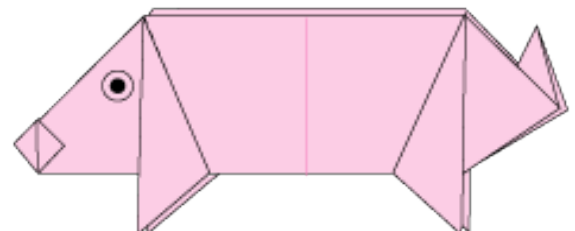

11 Dessinez les yeux

*Copyright: Fumiaki Shingu

Un cochon

Origami

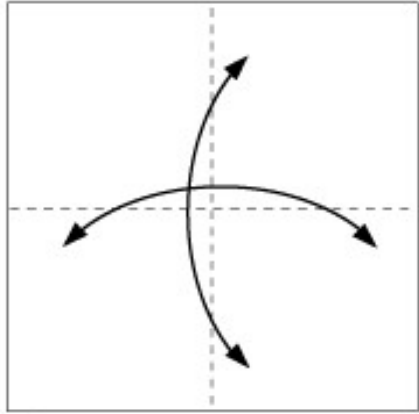
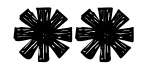

1

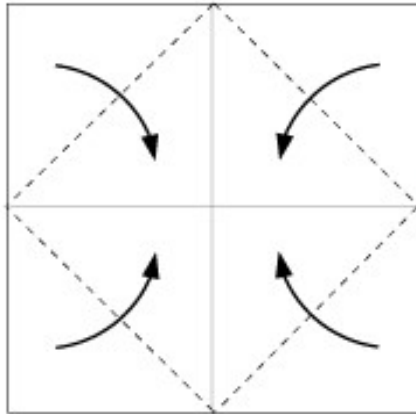

2

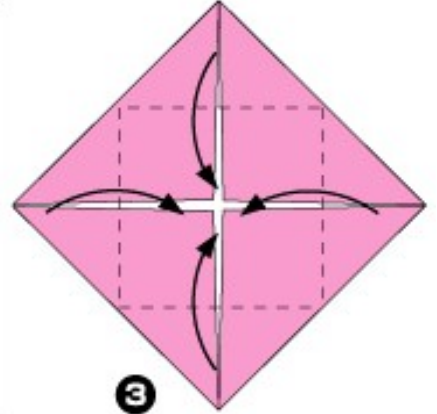

3

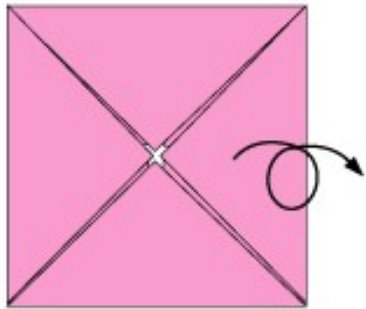

4

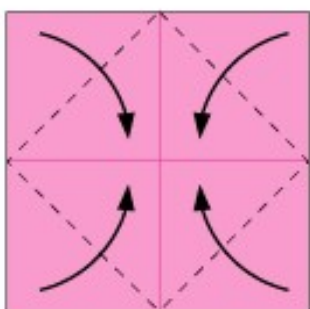

5

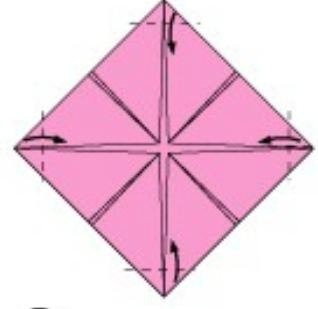

6

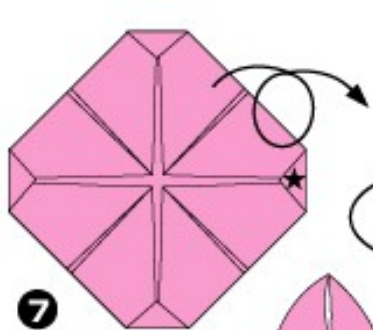

7

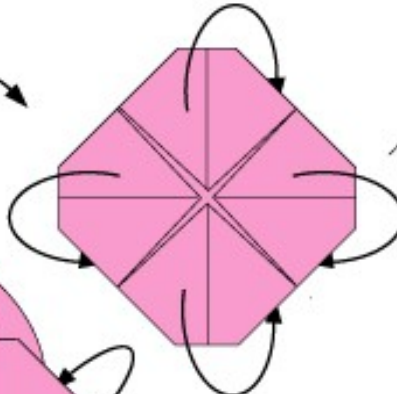

8

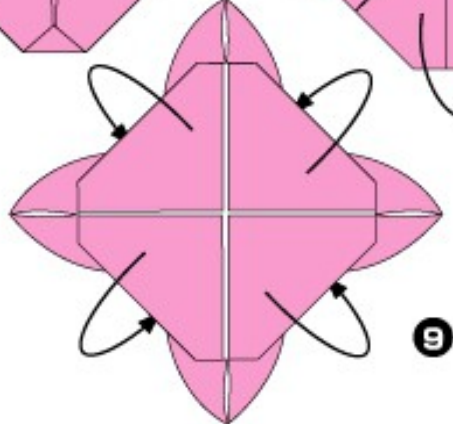
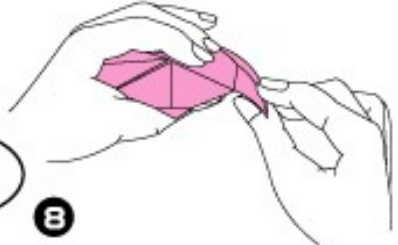

9

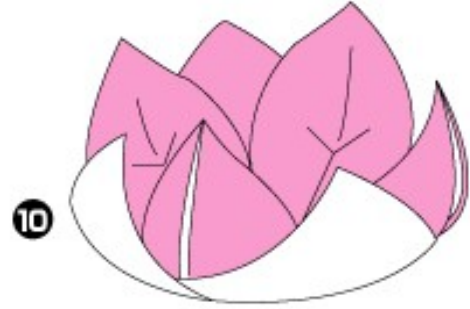

10

Origami

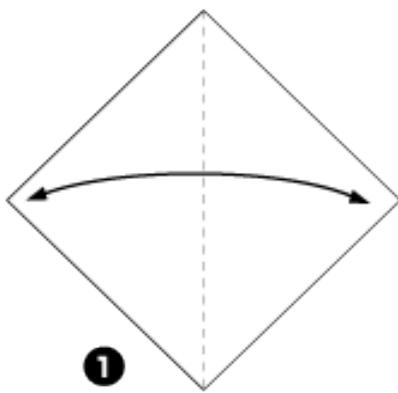
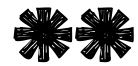

1
Pliez-en deux
pour marquer le pli

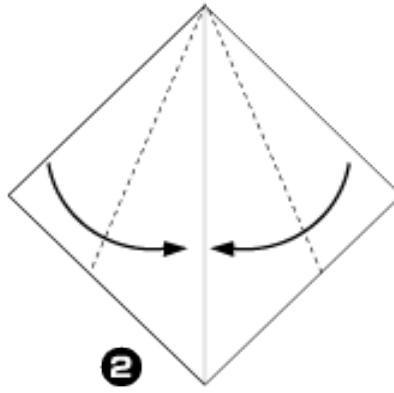

2
Pliez vers le centre
de la feuille

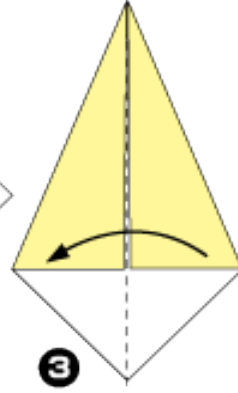

3
Pliez en deux

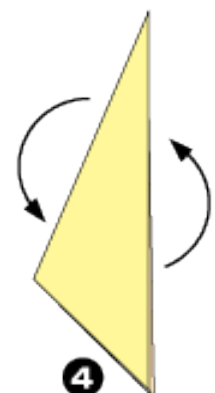

4
Change de côté

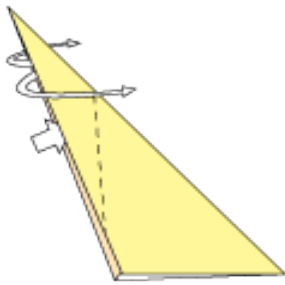

5 Abra sobre ↗ y recúbralo

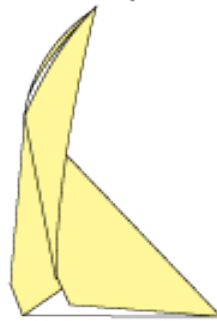

6 Ouvrez

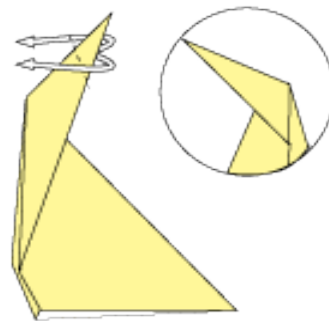

7 Contre pliage vers l'extérieur
sur les pointillés

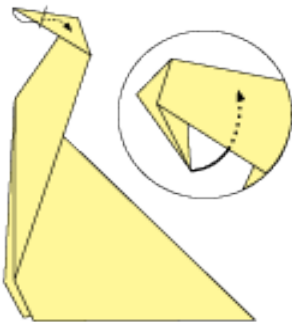

8 Pliez

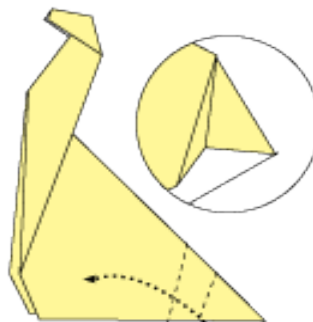

9 Contre pliage vers l'intérieur
sur les pointillés

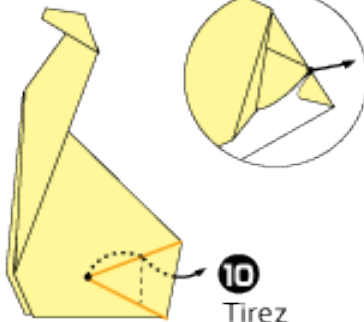

10
Tirez



11
Coupez avec
les ciseaux



12
Dessinez la forme
du visage et le motif

Origami

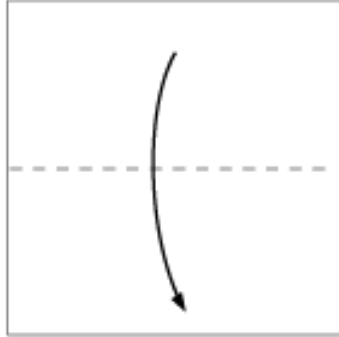

1 Pliez en deux

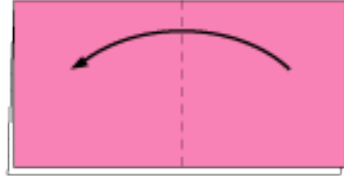

2 Pliez en deux



3 Abra sobre ↗ y recùbralo

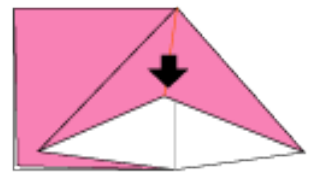

4 J'ai ecrase

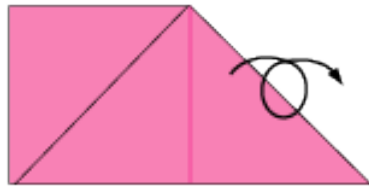

5 Changez de côté

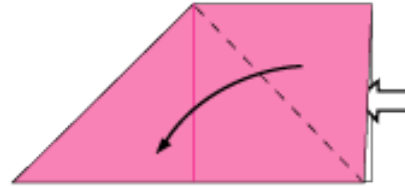

6 Abra sobre ↗ y recùbralo



7 Pliez vers le centre de la feuille

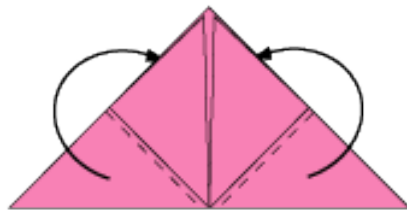

8 Pliez la feuille en arrière sur les pointillés

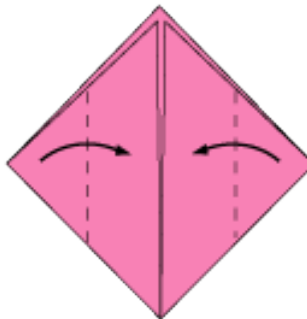

9 Pliez sur les pointillés

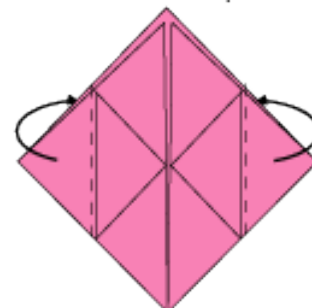

10 Pliez la feuille en arrière sur les pointillés



11 Pliez et glissez



12 Aerer

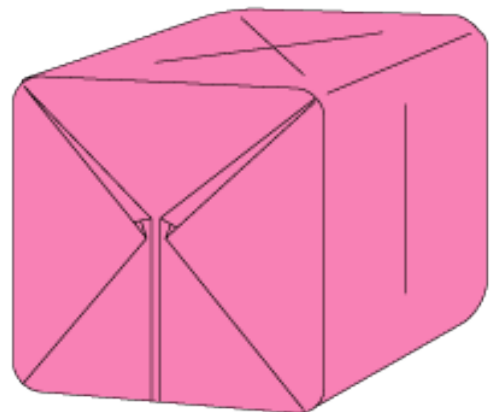

13 C'est fini

Un ballon

Origami



1 Pliez en deux

2 Pliez en deux

3 Abra sobre ↗ y recúbralo

4 Changez de côté

5 Marquez le pli

6 Abra sobre ↗ y recúbralo

7 Pliez sur les pointillés

8 Pliez sur les pointillés

9 Pliez sur les pointillés

10 Pliez sur les pointillés

11 Pliez la feuille en arrière sur les pointillés

12 Pliez sur les pointillés

13 Pliez sur les pointillés

14 Changez de côté

15 Pliez la feuille en avant sur les pointillés

16 Changez de côté

17

Père Noël

*Copyright:Fumiaki Shingu

Origami

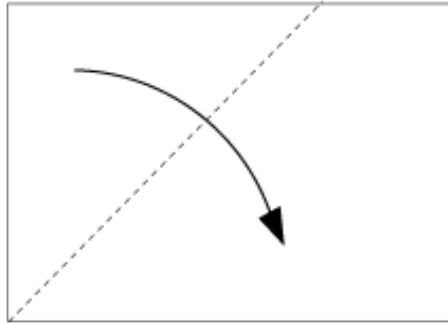

1 Pliez sur les pointillés

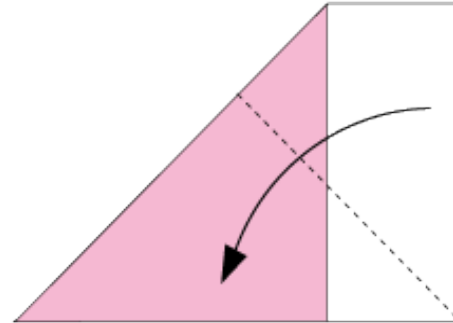

2 Pliez sur les pointillés

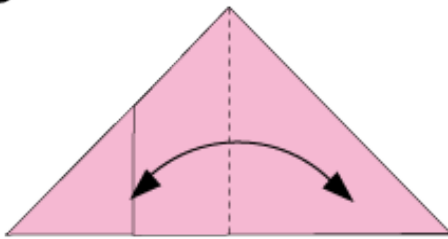

3 Marquez le pli

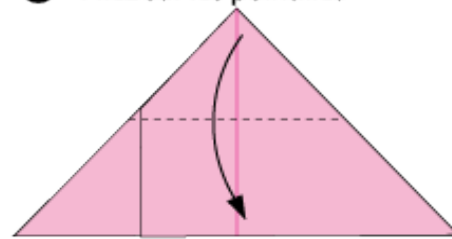

4 Pliez sur les pointillés

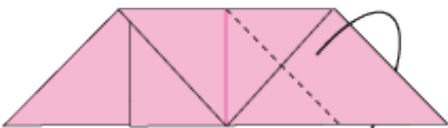

5 Pliez la feuille en arrière sur les pointillés

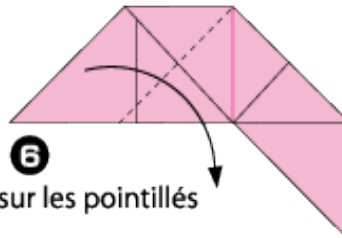

6 Pliez sur les pointillés

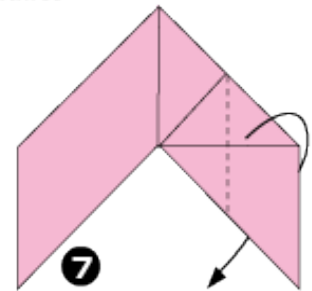

7 Pliez la feuille en arrière sur les pointillés

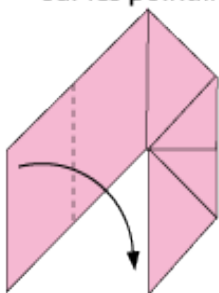

8 Pliez sur les pointillés

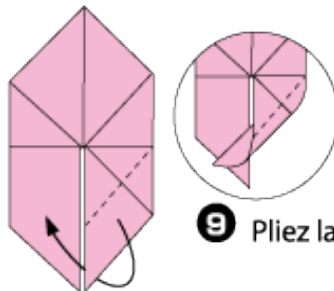

9 Pliez la feuille en avant sur les pointillés

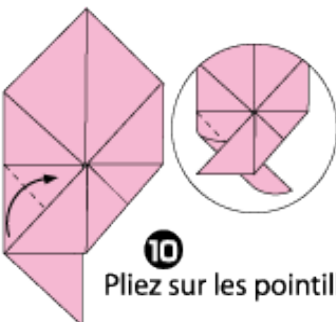

10 Pliez sur les pointillés

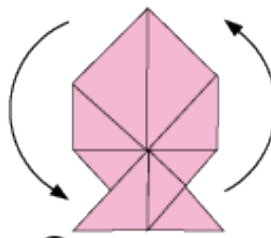

11 Cambie de lado

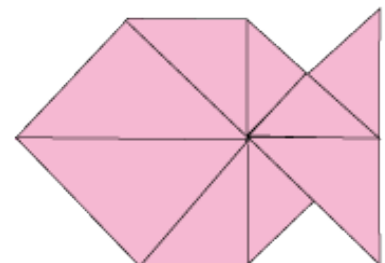

12 C'est fini

Origami

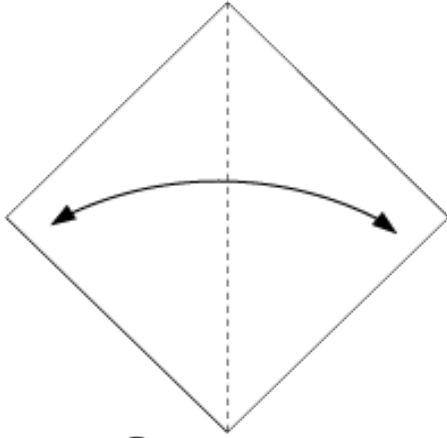

1

Pliez-en deux pour marquer le pli

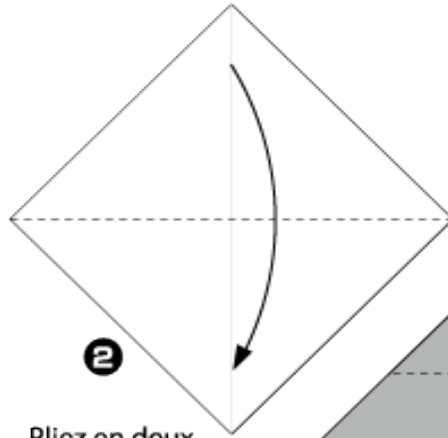

2

Pliez en deux

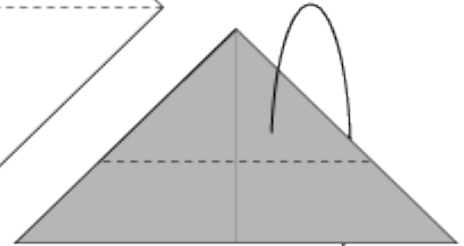

3

Pliez la feuille en arrière sur les pointillés

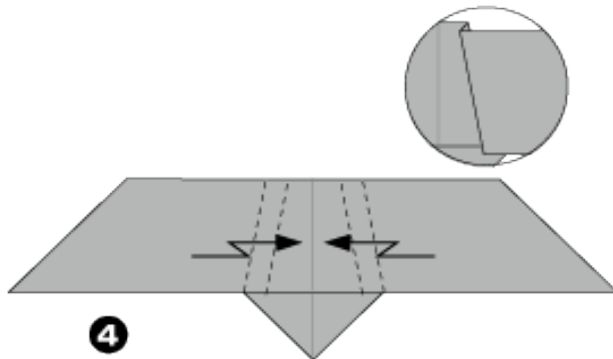

4

Pliez en accordéon sur les pointillés

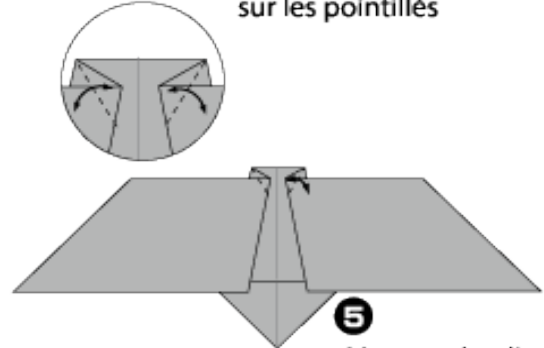

5

Marquez le pli

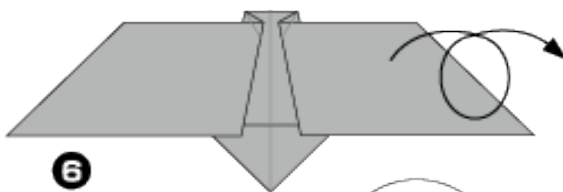

6

Changez de côté

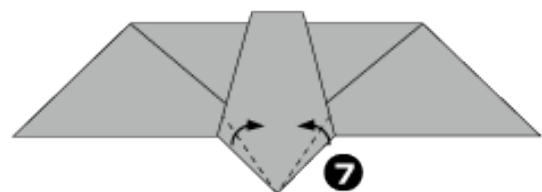

7

Pliez sur les pointillés

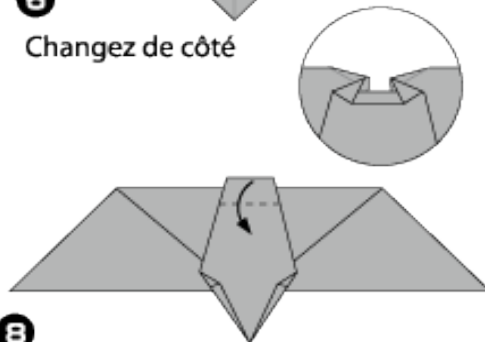

8

Pliez sur les pointillés

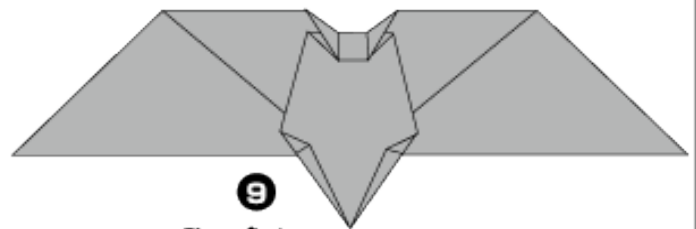

9

C'est fini

Origami

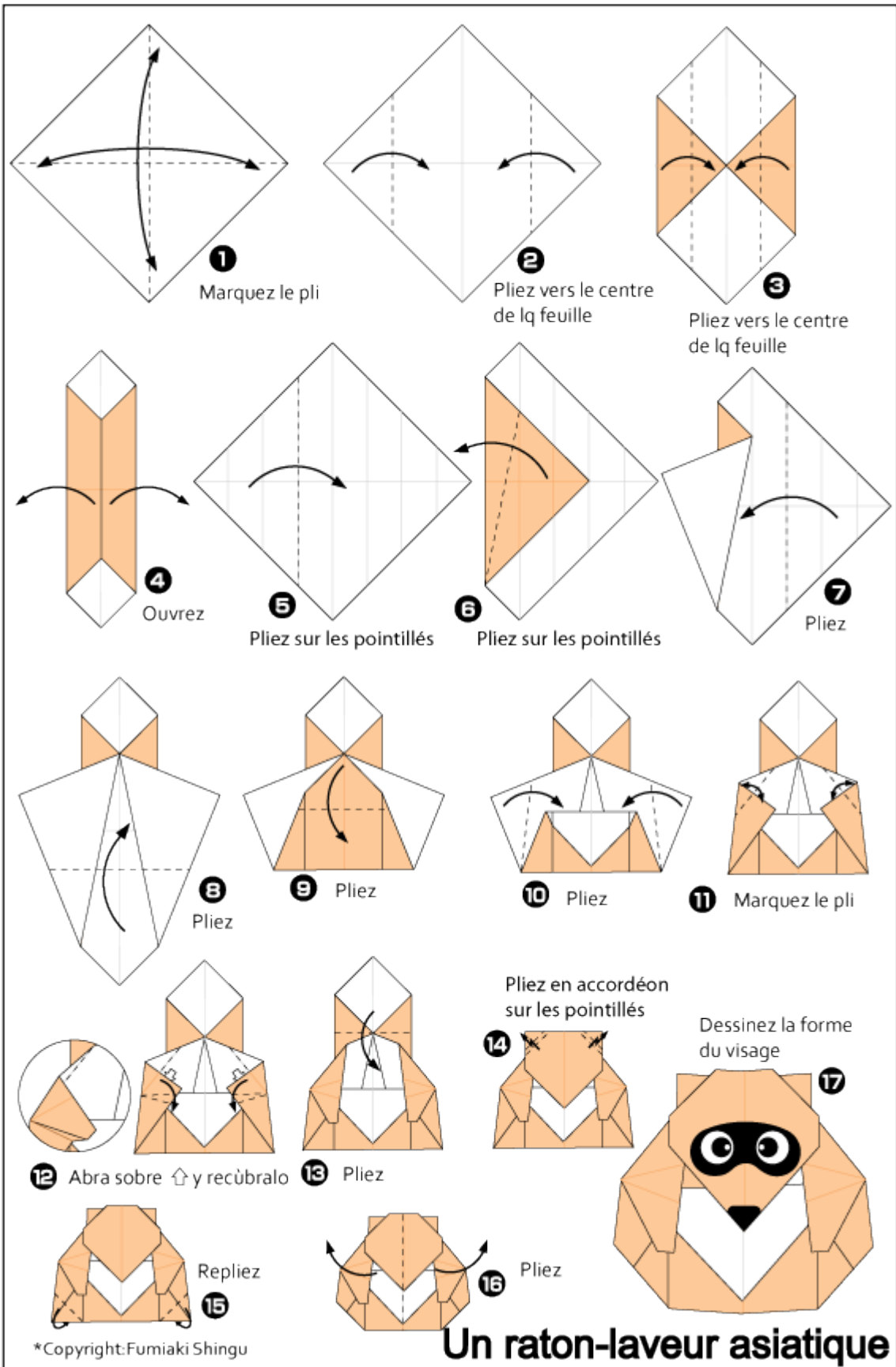

Origami

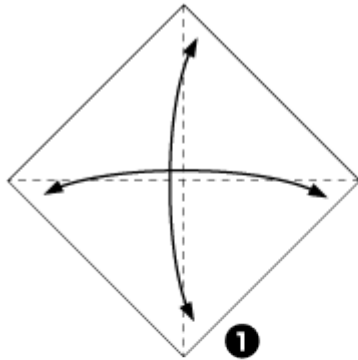
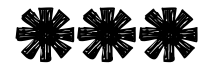

1 Marquez le pli

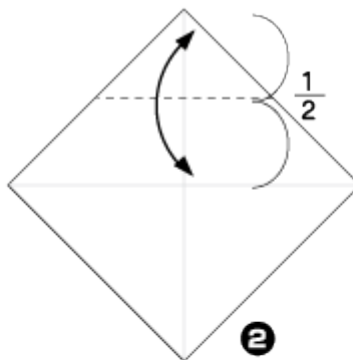

2 Marquez le pli

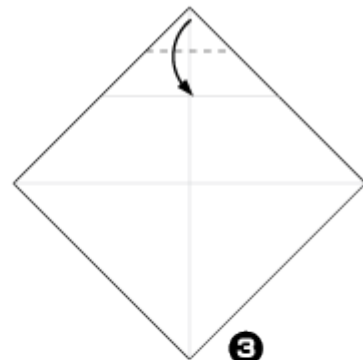

3 Pliez sur les pointillés

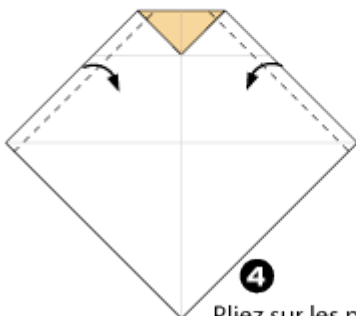

4 Pliez sur les pointillés

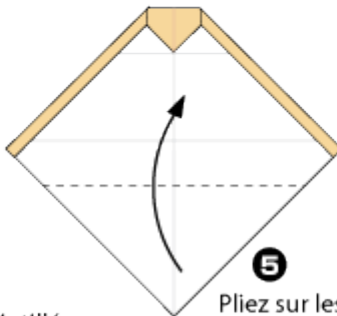

5 Pliez sur les pointillés

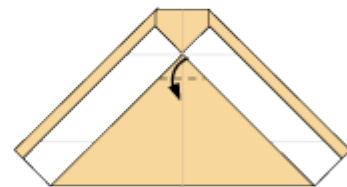

6 Pliez sur les pointillés

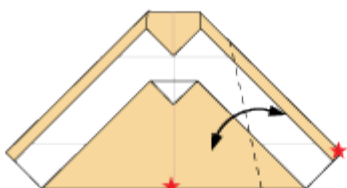

7 ★ Marquez le pli

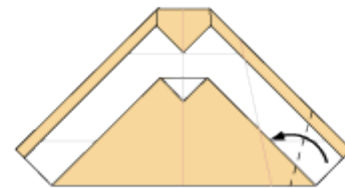

8 Pliez sur les pointillés

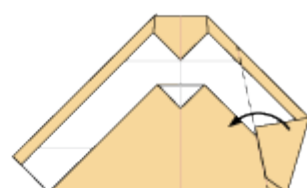

9 Pliez sur les pointillés

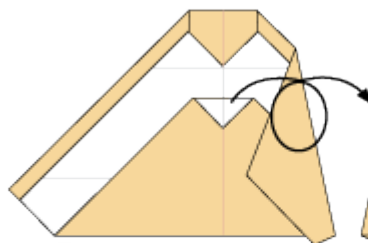

10 Changez de côté

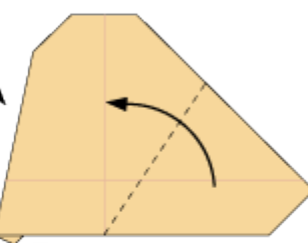

11 Pliez sur les pointillés
Pliez sur les pointillés

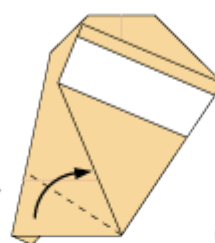

12 Pliez sur les pointillés

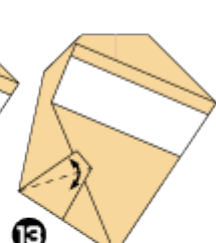

13 Marquez le pli



14 Abra sobre ↗ y recúbralo

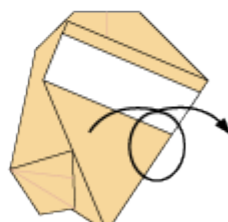

15 Changez de côté



16 Repliez
Dessinez la forme
du visage et le motif

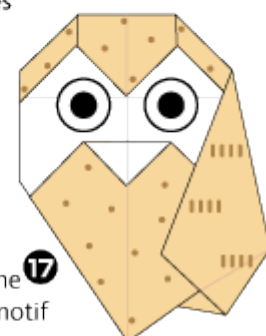

17 Un hibou

Origami

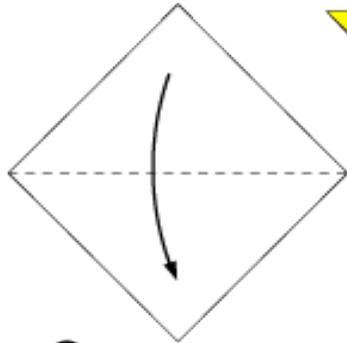

1 Pliez en deux

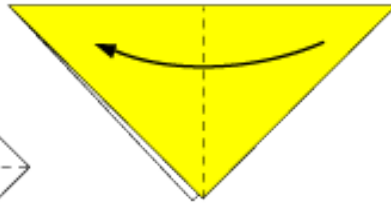

2 Pliez en deux

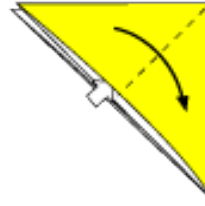

3 Abra sobre ↗ y recúbralo

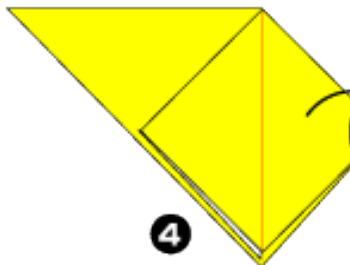

4

Changez de côté

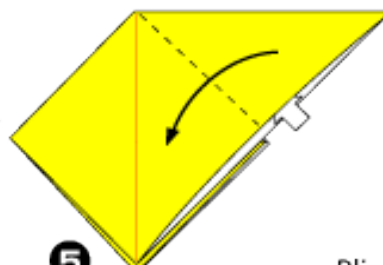

5

Abra sobre ↗ y recúbralo

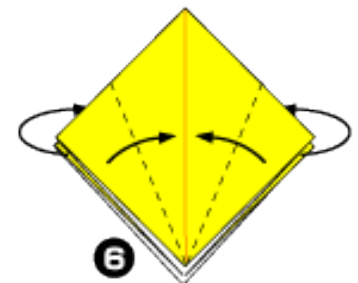

6

Pliez la feuille jusqu'aux pointillés puis répétez sur l'autre côté de la feuille

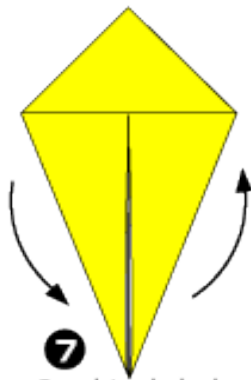

7

Cambie de lado

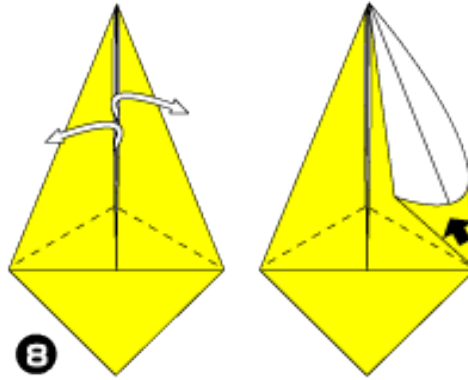

8

Abra sobre ↗ y recúbralo

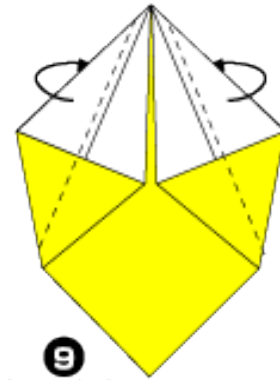

9

Pliege la hoja para atras y repita sobre la otra cara de la hoja

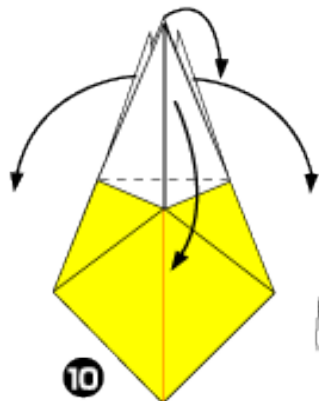

10

Pliez
Répétez les autres côtés

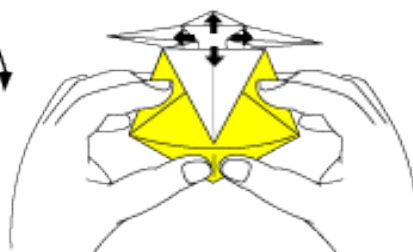

11

Crush le bas.
Tartiner l'intérieur.

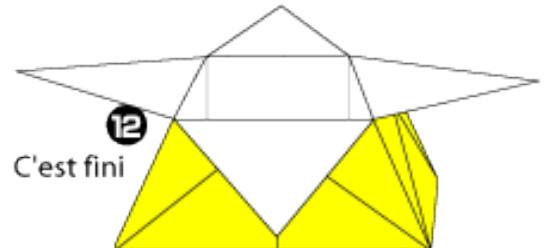

12

C'est fini

Boîte décorative